



**Electric scissor lift**  
JCPT1012HD

# Electric scissor lift JCPT1012HD









## STANDARD EQUIPMENT

- Proportional controls
- Automatic pothole protection
- Self-lock gate on platform
- Drivable at full height
- Non-marking tires
- 2WD
- Automatic brakes system
- Emergency lowering system
- Emergency stop button
- Cylinder holding valve
- Onboard diagnostic system
- Tilt sensor with alarm
- All motion alarm
- Horn
- Hour meter
- Safety brackets
- Forklift pockets
- Folding guardrails
- Extended platform
- Charger protection
- Flashing beacon

## OPTIONS

- Overload sensor with alarm
- AC power to the platform
- Platform work lights
- Airline to the platform

## SPECIFICATIONS

	Platform capacity (SWL)..... <b>450 kg</b> Platform capacity (SWL) on extension..... <b>113 kg</b> Maximum workers number ..... <b>2</b>
	Working height ..... <b>10,0 m</b> Platform floor height..... <b>8,0 m</b>
	Overall length ..... <b>2,48 m</b> Overall width..... <b>1,15 m</b> Overall height (Rails up)..... <b>2,32 m</b> Overall height (Rails down)..... <b>1,78 m</b> Platform size..... <b>2,27 x 1,12 m</b> Platform extension size..... <b>0,9 m</b> Ground clearance (Stowed) ..... <b>0,10 m</b> Ground clearance (Raised) ..... <b>0,019 m</b> Wheelbase ..... <b>1,87 m</b> Turning radius (inside)..... <b>0 m</b> Turning radius (outside)..... <b>2,20 m</b>
	Lifting motor ..... <b>24 V / 3 kw</b> Driving motor ..... <b>24 V / 1,5 kw</b>
	Travel speed (Stowed) ..... <b>4 km / h</b> Travel speed (Raised) ..... <b>0,8 km / h</b> Up / Down speed..... <b>36 / 33 sec</b>
	Batteries ..... <b>4 x 6 V / 210 Ah</b> Integrated charger..... <b>24 V / 25 A</b>
	Gradeability ..... <b>25 %</b> Maximum working slope..... <b>1,5 - 3 °</b>
	Tires ..... <b>Ø 381 x 127 mm</b>
	Weight ..... <b>2655 kg</b>

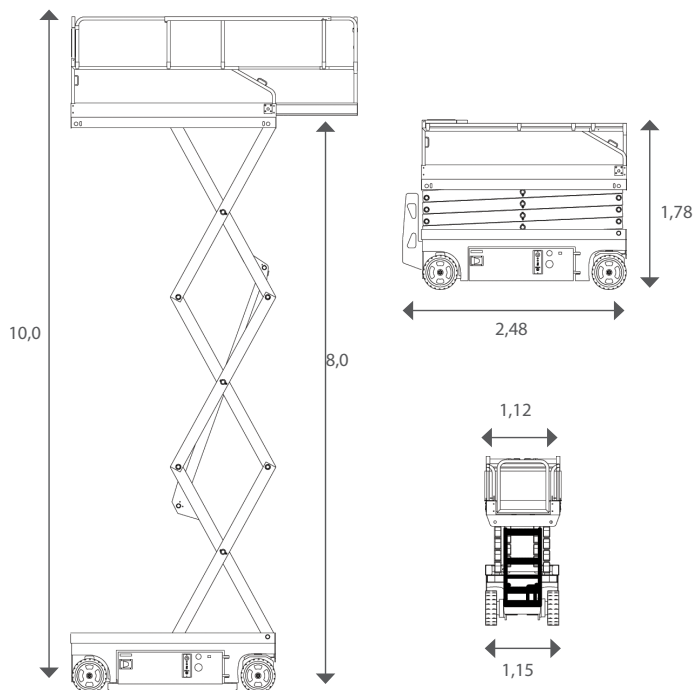

**CE** This product is available with the CE mark confirming compliance with all relevant European Machinery Directives

[www.dingli.eu](http://www.dingli.eu)

**INSTANT**

**Norway**  
Tel.: +47 23 19 11 00  
info@instant.no

**Lithuania**  
Tel.: +370 5 233 1096  
info@instant.lt

**Latvia**  
Tel.: + 371 263 58 152  
info@instantlatvija.lv

**Estonia**  
Tel.: +372 680 76 33  
info@instant.ee